

OPTION 3 - SOUTH ELEVATION

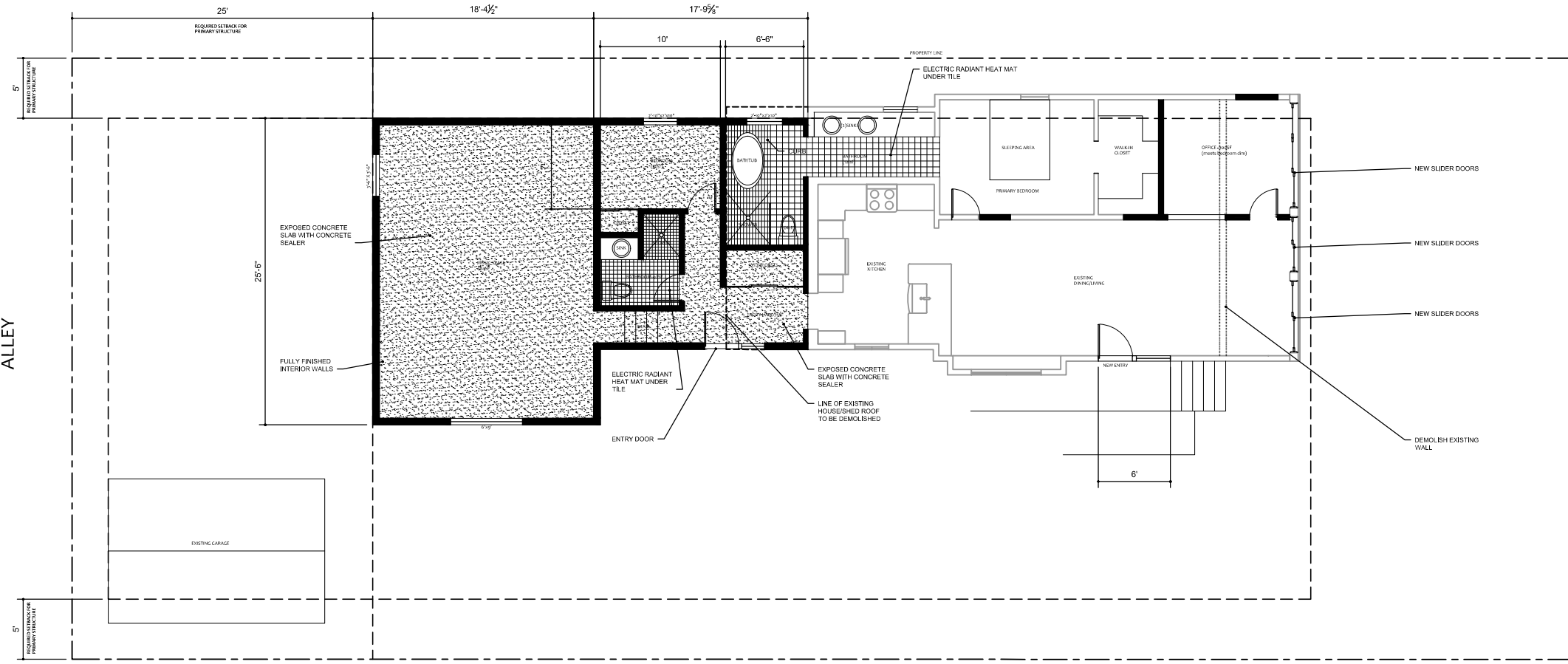

OPTION 2 - EAST ELEVATION



OPTION 1

PROJECT:
RESIDENTIAL REMODEL
ERIC ELVEN & AILEEN ASCHE
5120 N HIGHLAND ST
RUSTON WA

FRANCIS CREATIVE
SCOTT FRANCIS
ARCHITECT
2113 30TH AVE S
SEATTLE WA 98144
206.778.0416

ISSUED:
CONCEPT DRAWINGS
11/10/21
CONCEPT DRAWINGS
11/18/21
CONCEPT DRAWINGS
11/28/21

SHEET 1

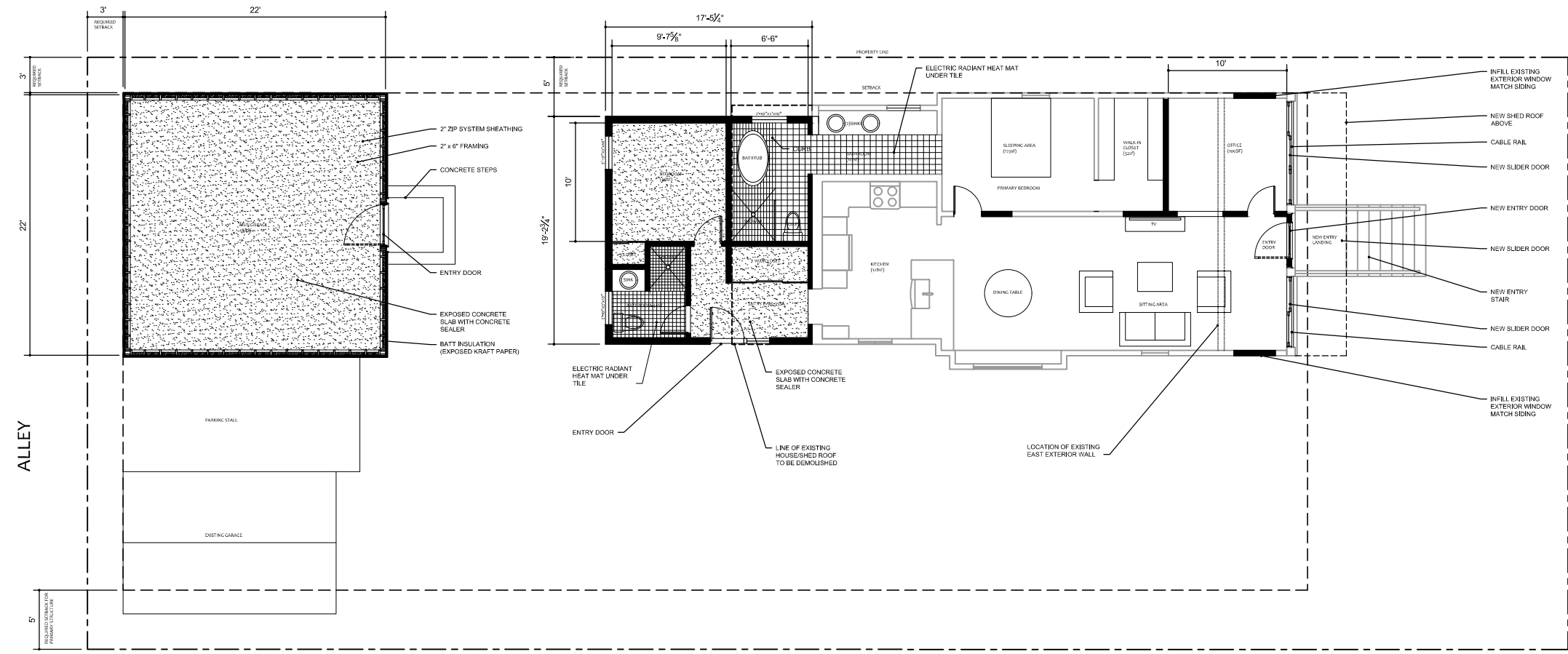
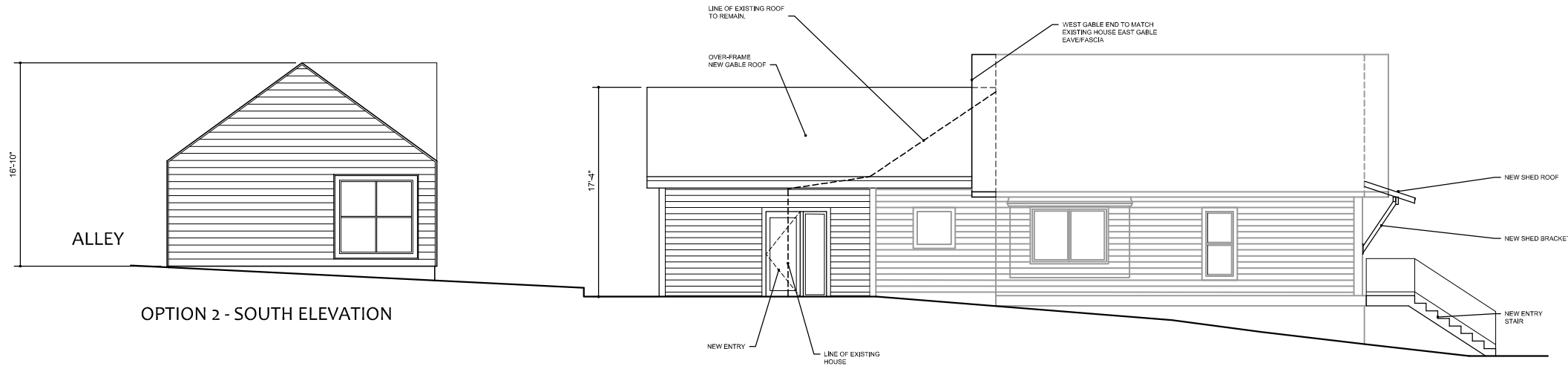

PROJECT:
RESIDENTIAL REMODEL
ERIC ELVEN & AILEEN ASCHE
5120 N HIGHLAND ST
RUSTON WA

FRANCIS CREATIVE
SCOTT FRANCIS
ARCHITECT
2113 30TH AVE S
SEATTLE WA 98144
206.778.0416

ISSUED:
CONCEPT DRAWINGS
11/10/21
CONCEPT DRAWINGS
11/18/21
CONCEPT DRAWINGS
11/28/21

SHEET 2

PROJECT:
RESIDENTIAL REMODEL
ERIC ELVEN & AILEEN ASCHE
5120 N HIGHLAND ST
RUSTON WA

FRANCIS CREATIVE
SCOTT FRANCIS
ARCHITECT
2113 30TH AVE S
SEATTLE WA 98144
206.778.0416

ISSUED:

CONCEPT DRAWINGS
11/10/21

CONCEPT DRAWINGS
11/18/21

CONCEPT DRAWINGS
11/28/21

SHEET 3

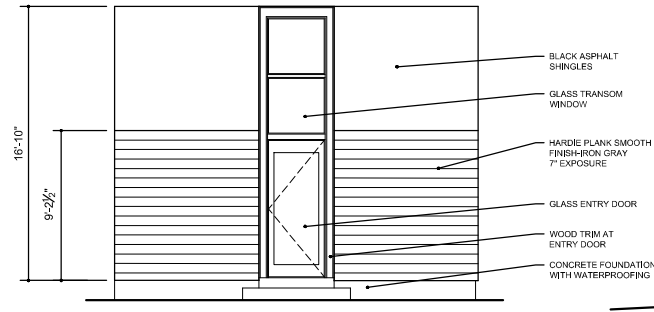
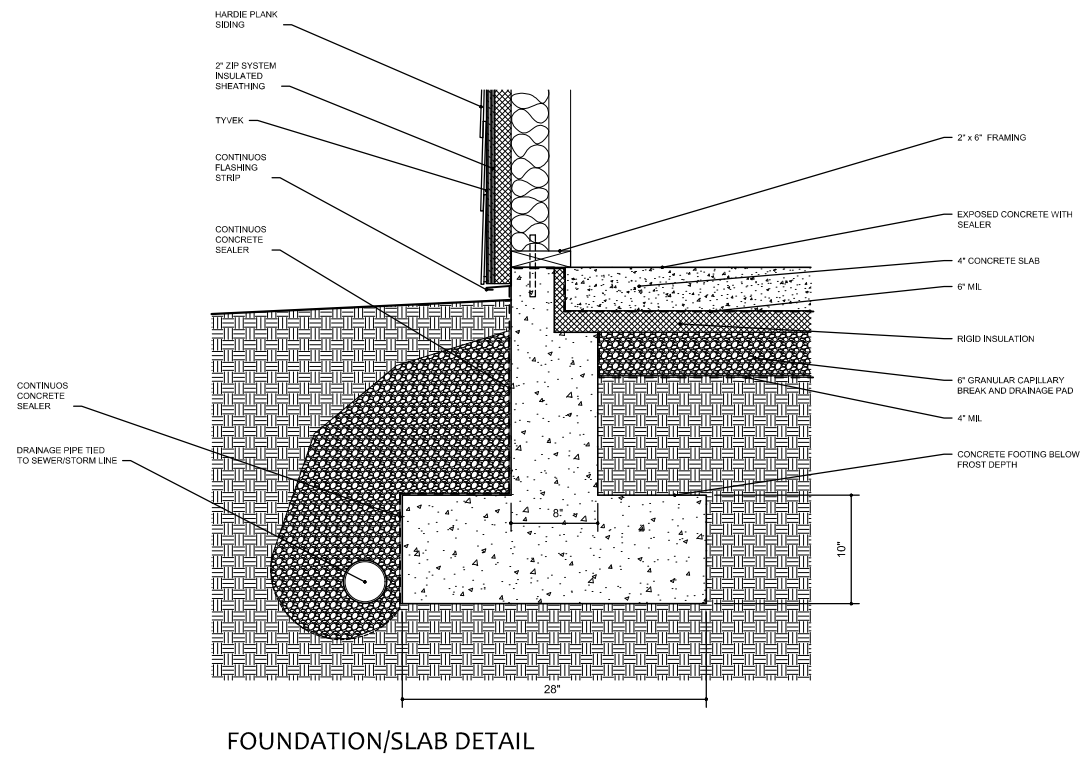

OPTION 2 - EAST ELEVATION

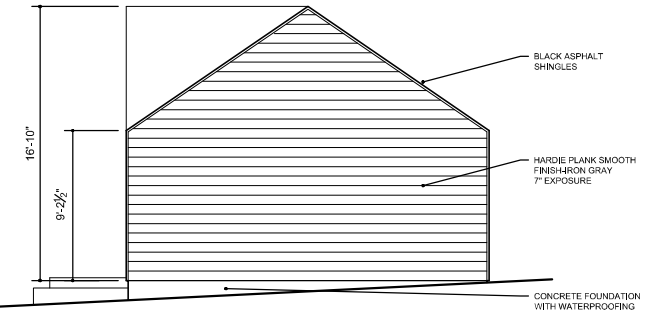

OPTION 2 - NORTH ELEVATION

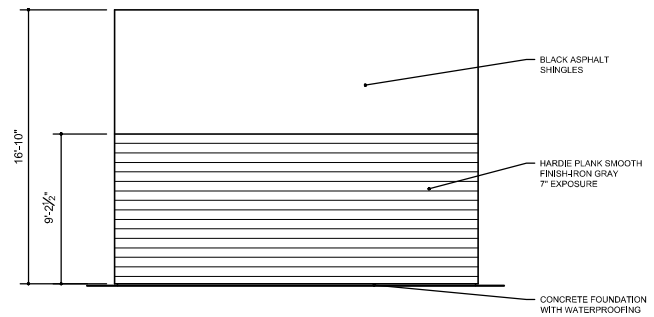

OPTION 2 - WEST ELEVATION

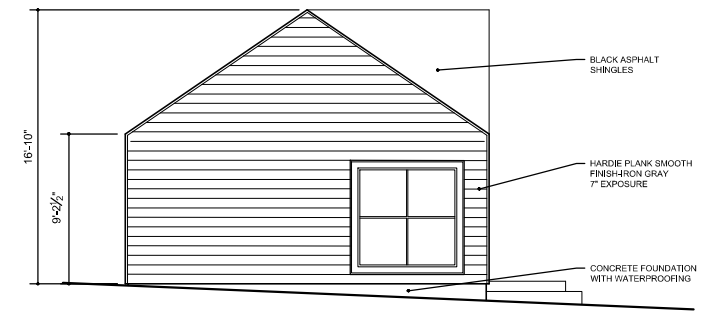

OPTION 2 - SOUTH ELEVATION

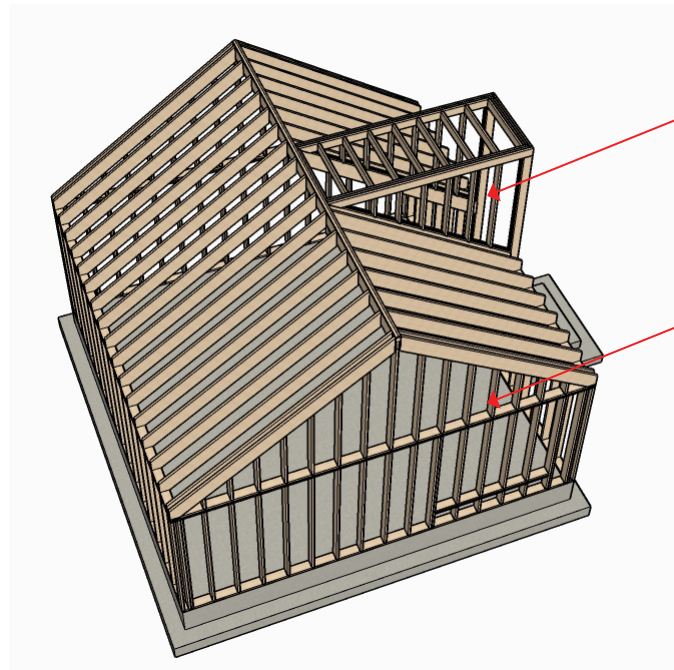

2"x 6" FRAMING AT ENTRY

2"x 6" FRAMING

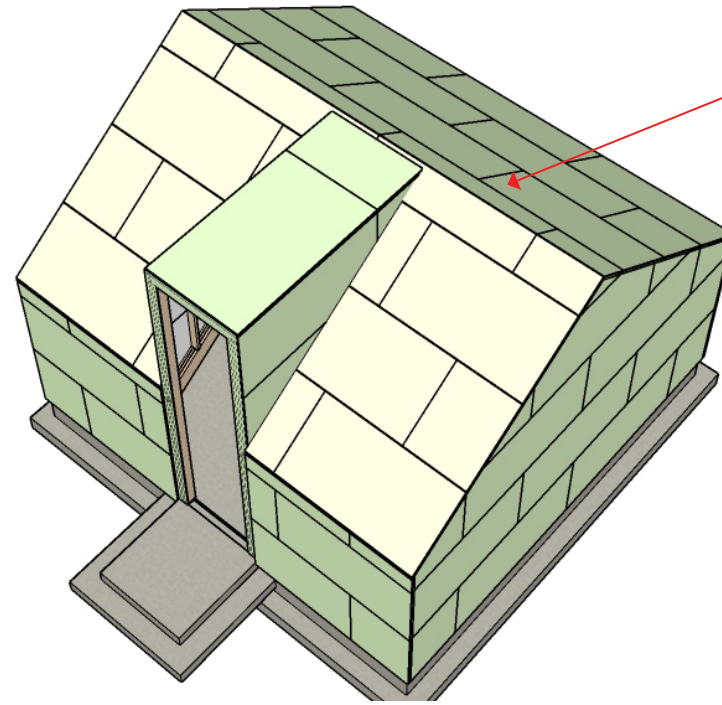

2" ZIP SYSTEM INSULATED SHEATHING

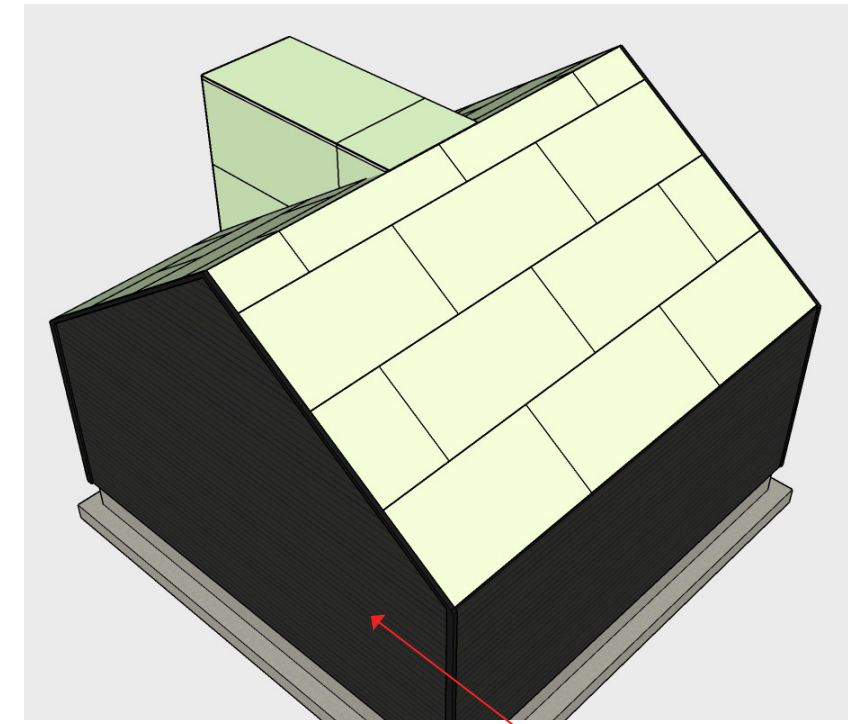

HARDIE PLANK HORIZONTAL SIDING

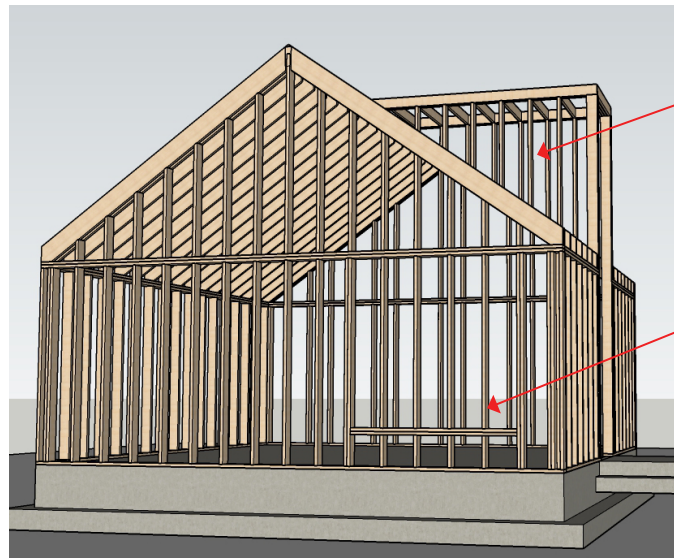

2"x 6" FRAMING AT ENTRY

2"x 6" FRAMING

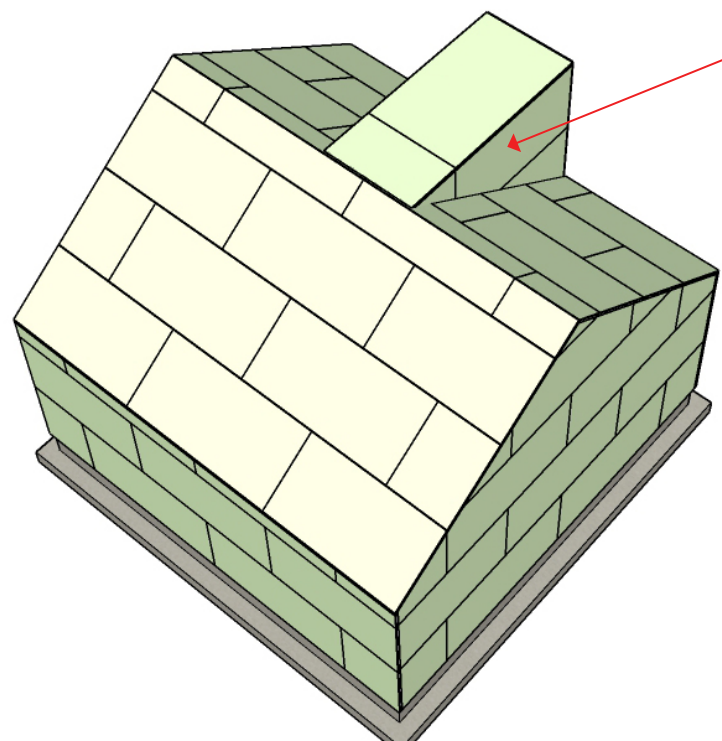

2" ZIP SYSTEM INSULATED SHEATHING

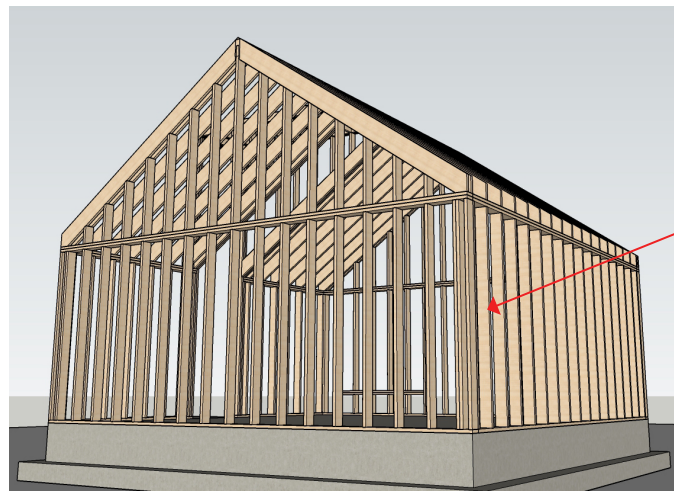

2"x 6" FRAMING

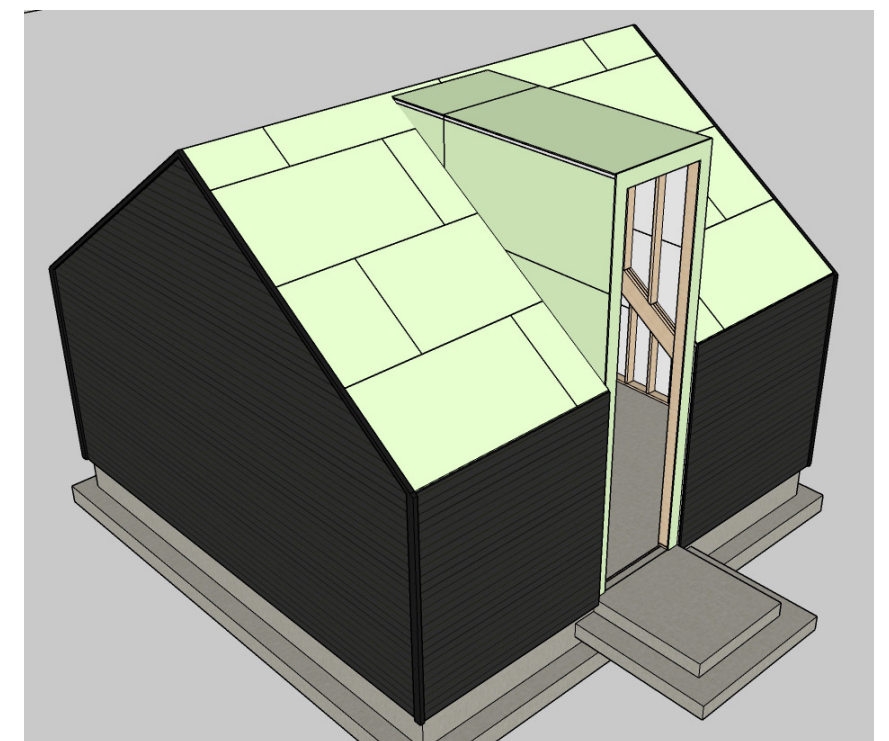

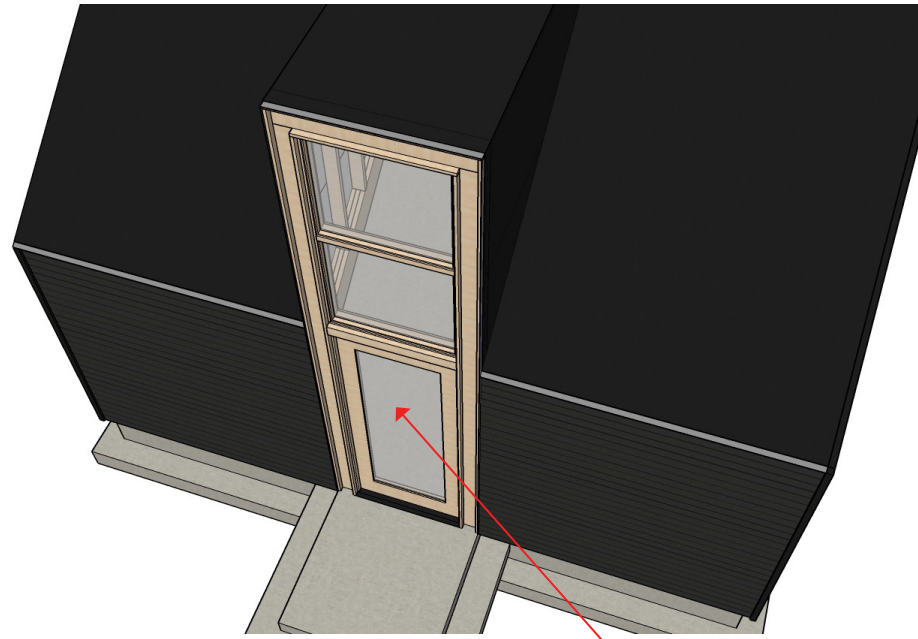

ENTRY DOOR:
GLASS & WOOD,
WOOD TRIM

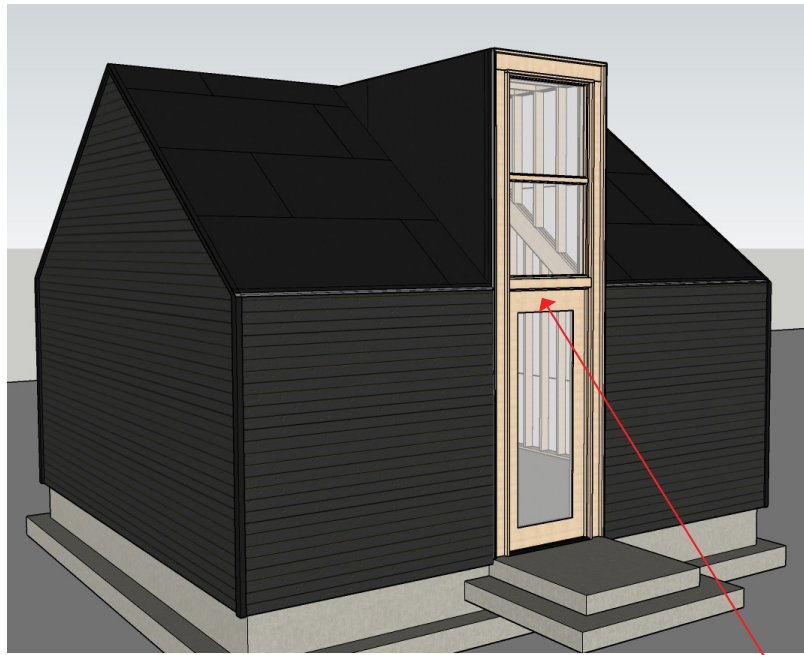

ENTRY DOOR:
GLASS & WOOD,
WOOD TRIM

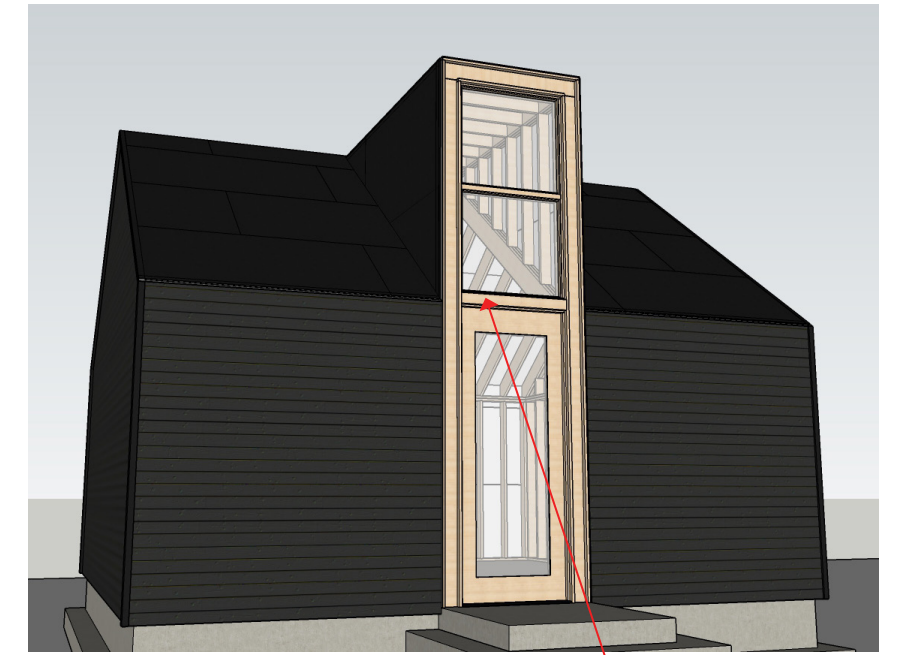

ENTRY DOOR:
GLASS & WOOD,
WOOD TRIM

ROOF: ASPHALT SHINGLE

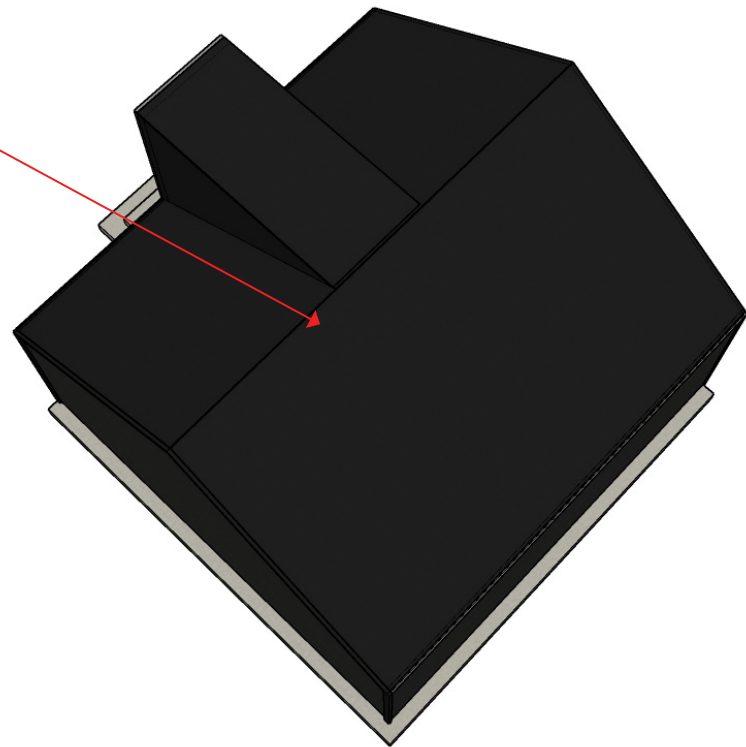

ROOF: ASPHALT SHINGLE

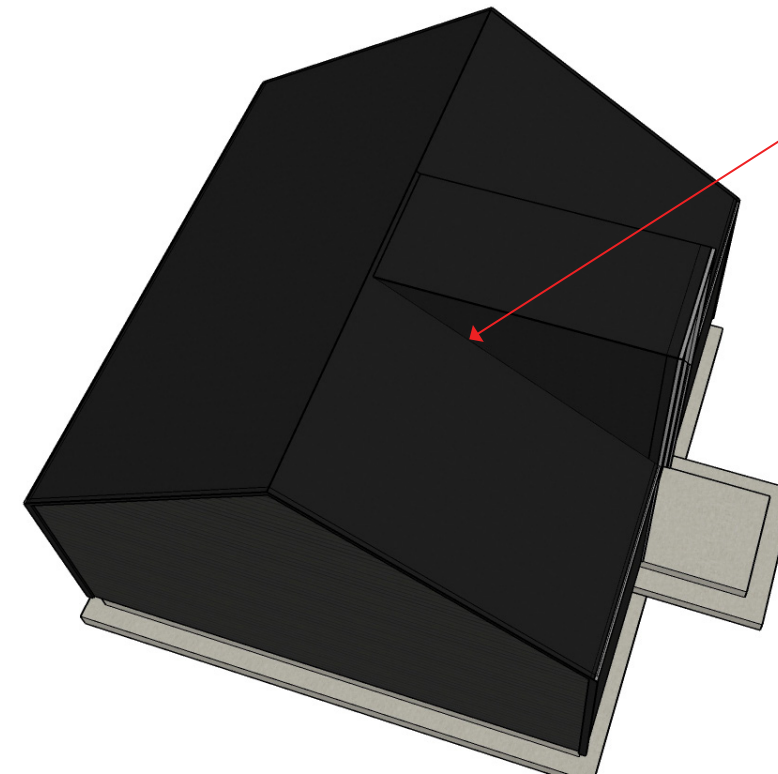

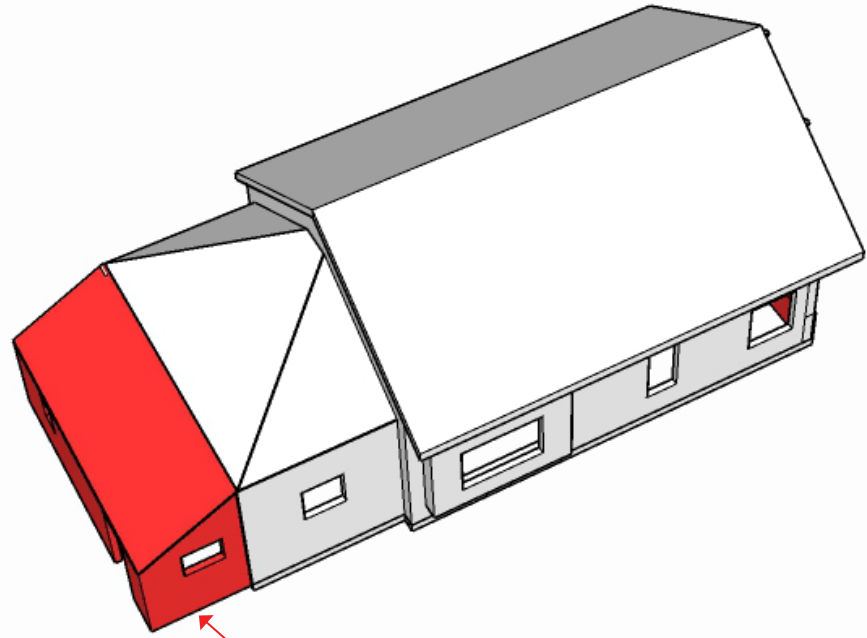

DEMO:
-EXISTING MUDROOM
-BATHROOM
- SHED ROOF

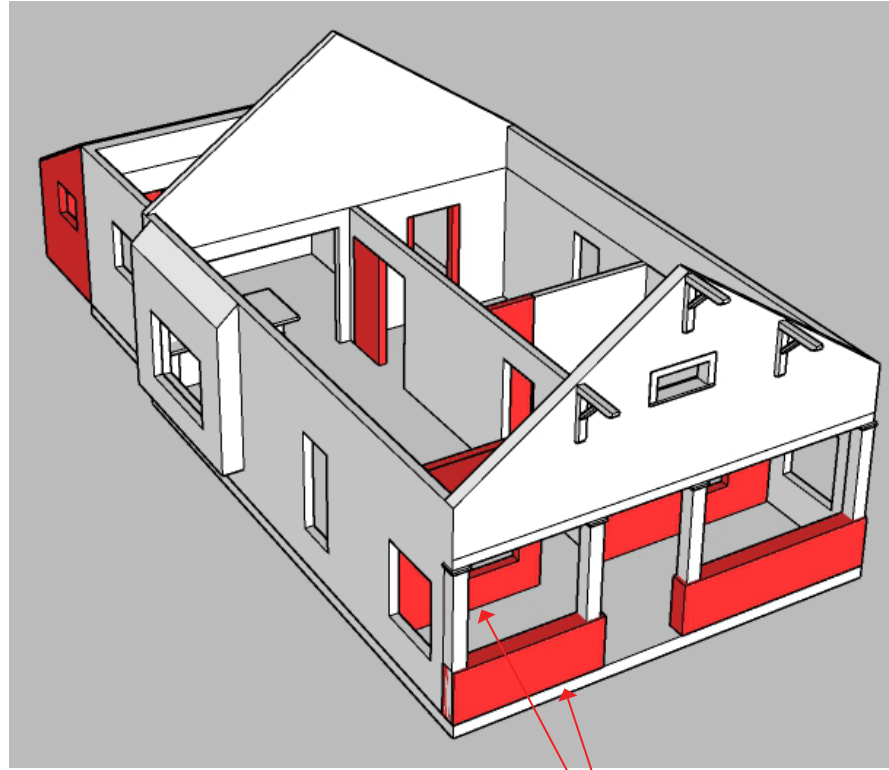

DEMO:
-EXISTING GUARDRAIL
-EAST EXTERIOR WALL
- VARIOUS INTERIOR WALL
SECTIONS

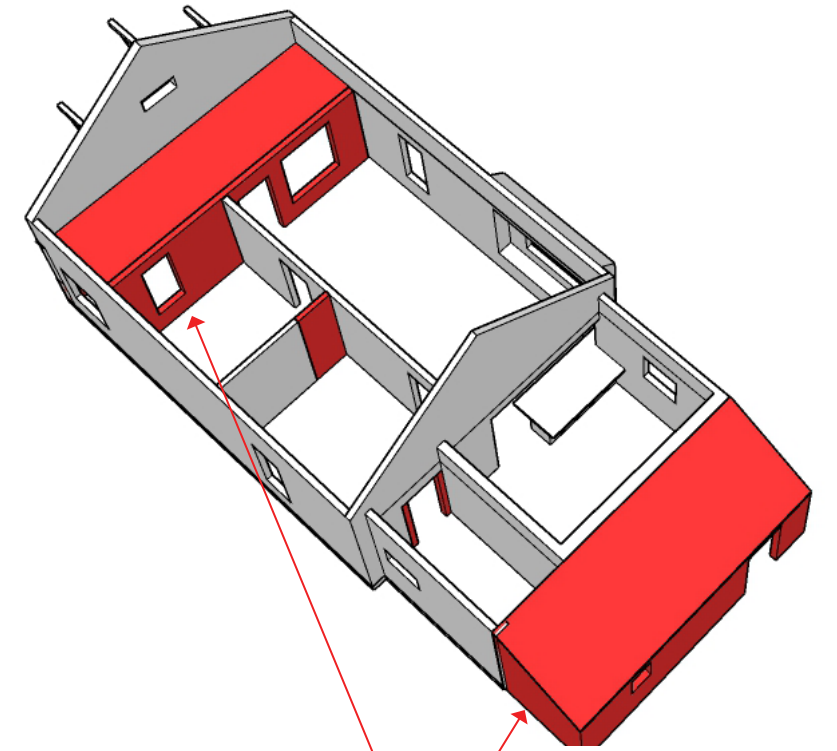

DEMO:
- EAST EXTERIOR WALL
- VARIOUS INTERIOR WALL
SECTIONS
- WEST; MUDROOM, SHOWER,
SHED ROOF



- ADDITIONS: (EAST SIDE)
- EXTERIO ENTRY DOOR
 - SLIDER DOORS
 - CABLE GUARDRAIL
 - ENTRY STAIR (NOT SHOWN)
 - SHED ROOF

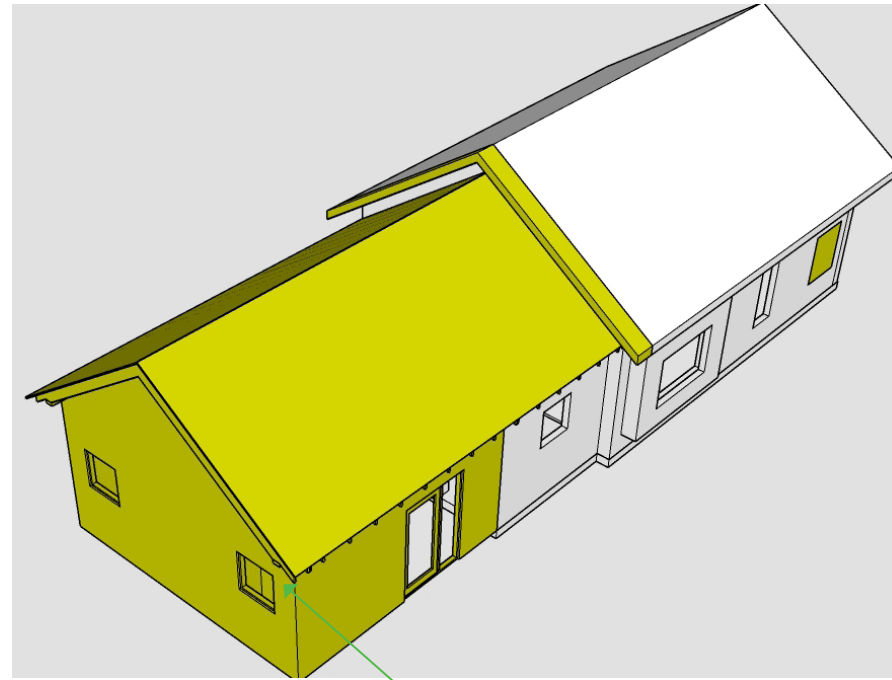

- ADDITIONS: (WEST SIDE)
- BEDROOM, BATHROOM
 - PRIMARY BATHROOM
 - LAUNDRY
 - ROOF

